

# ALL-OVER PENCIL SKIRT

Print file size

**46.5"** × **26.5"**  
width height

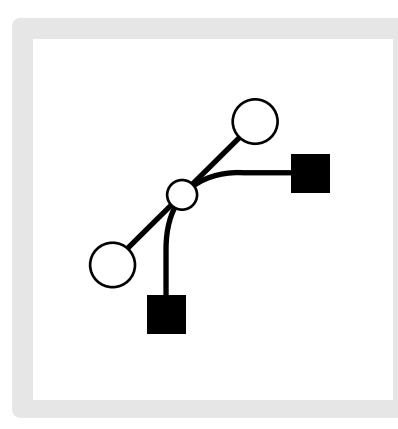

## FILE FORMAT

Please submit your files in **JPG, PNG** or **PSD** format.

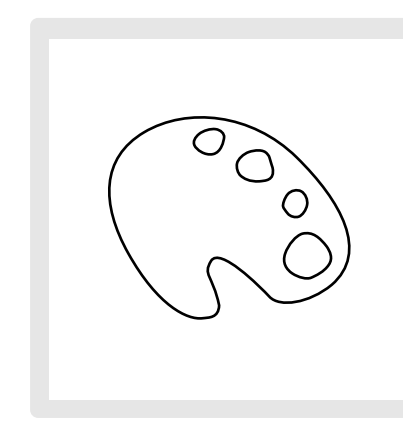

## COLOR

All colors should be in **RGB**.

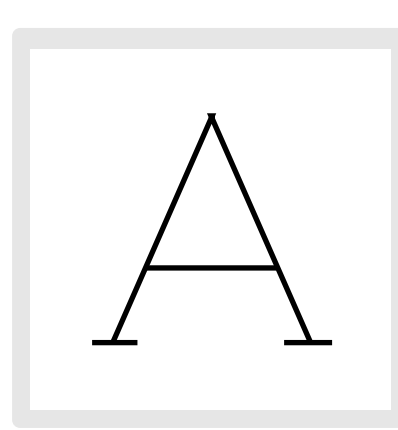

## FONTS

All fonts in the print files should be converted to outlines so you don't have to send over the font files.

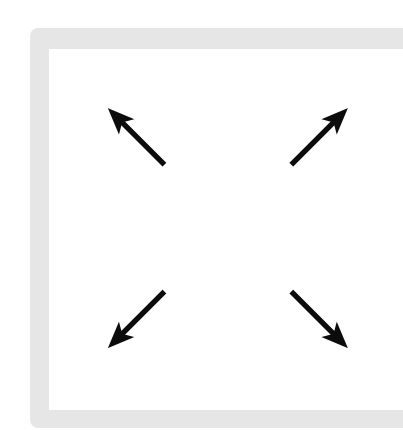

## PLACEMENT

Exact placement is **not possible**. Our pencil skirts are cut and sewn and are best when designed with patterns and full bleed images. Text placement will not be precise. Making a seamless image from front to back is impossible.

**NOTE: IF YOU WISH YOUR DESIGN TO MATCH ON SIDES FLIP IMAGE TO MIRROR**

THIS IS HOW THE SKIRT WILL LOOK IF YOU FLIP DESIGN TO MIRROR

### PRINT FILE

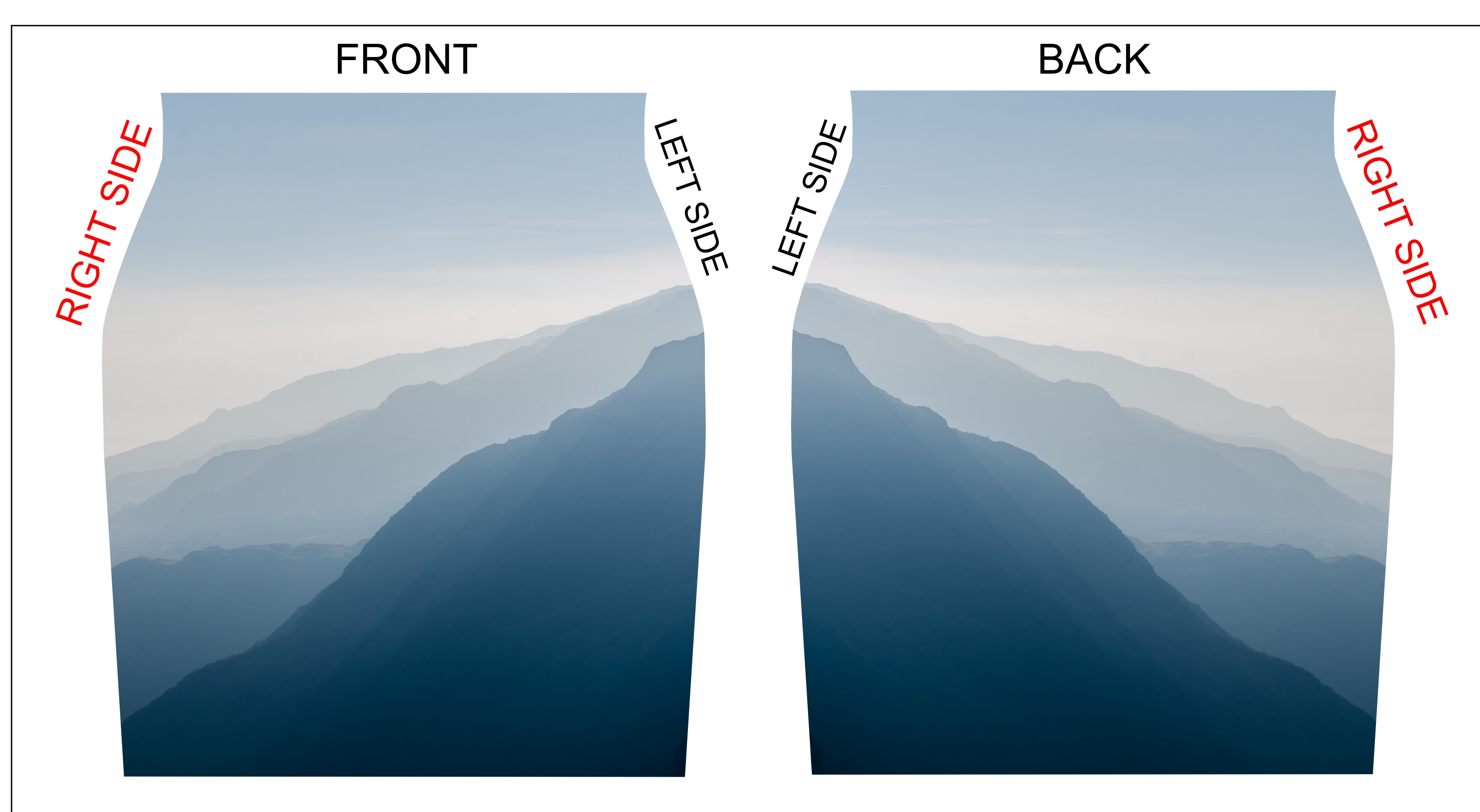
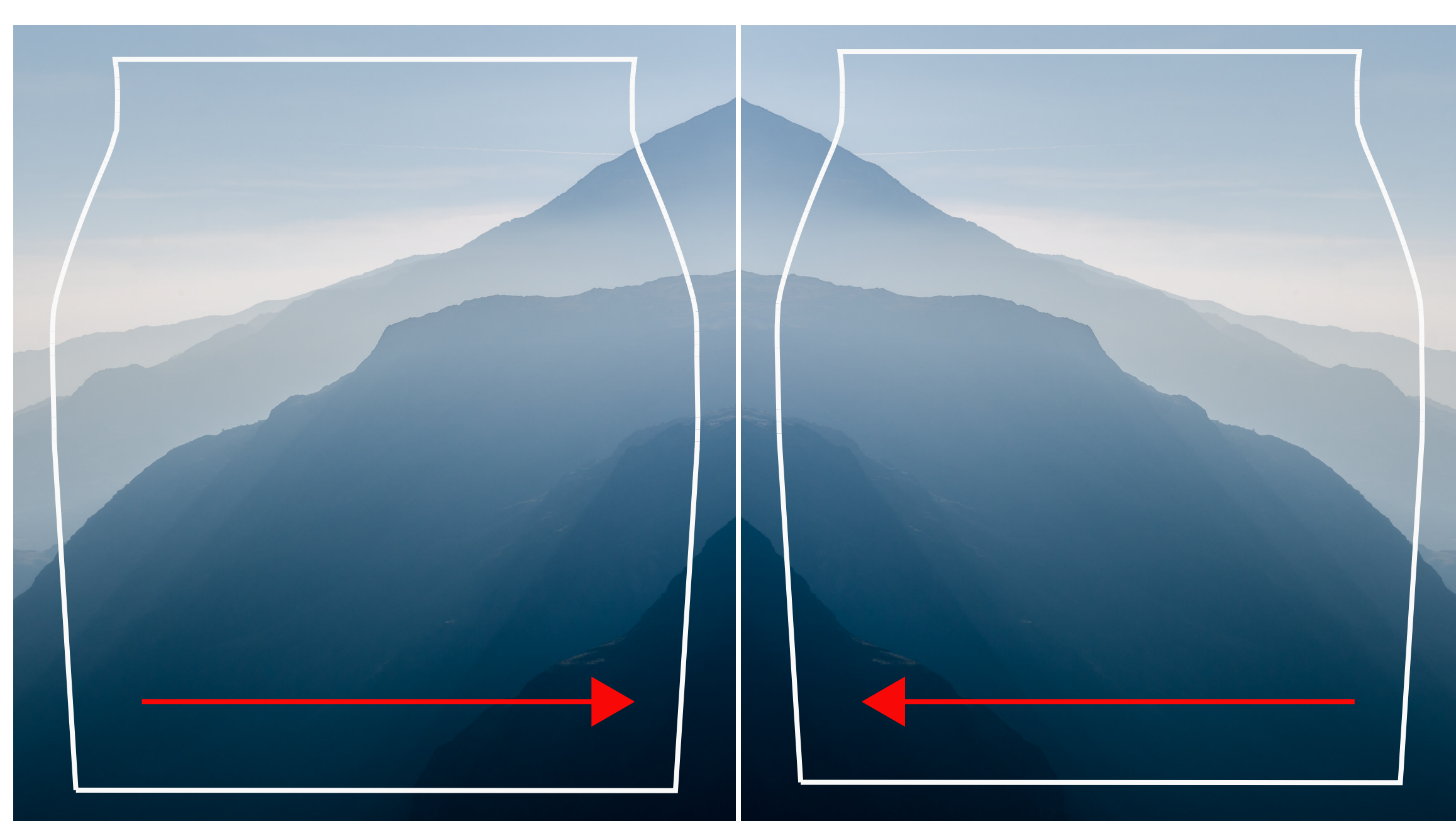

THIS IS HOW THE SKIRT WILL LOOK IF YOU **DON'T** FLIP DESIGN TO MIRROR

### PRINT FILE

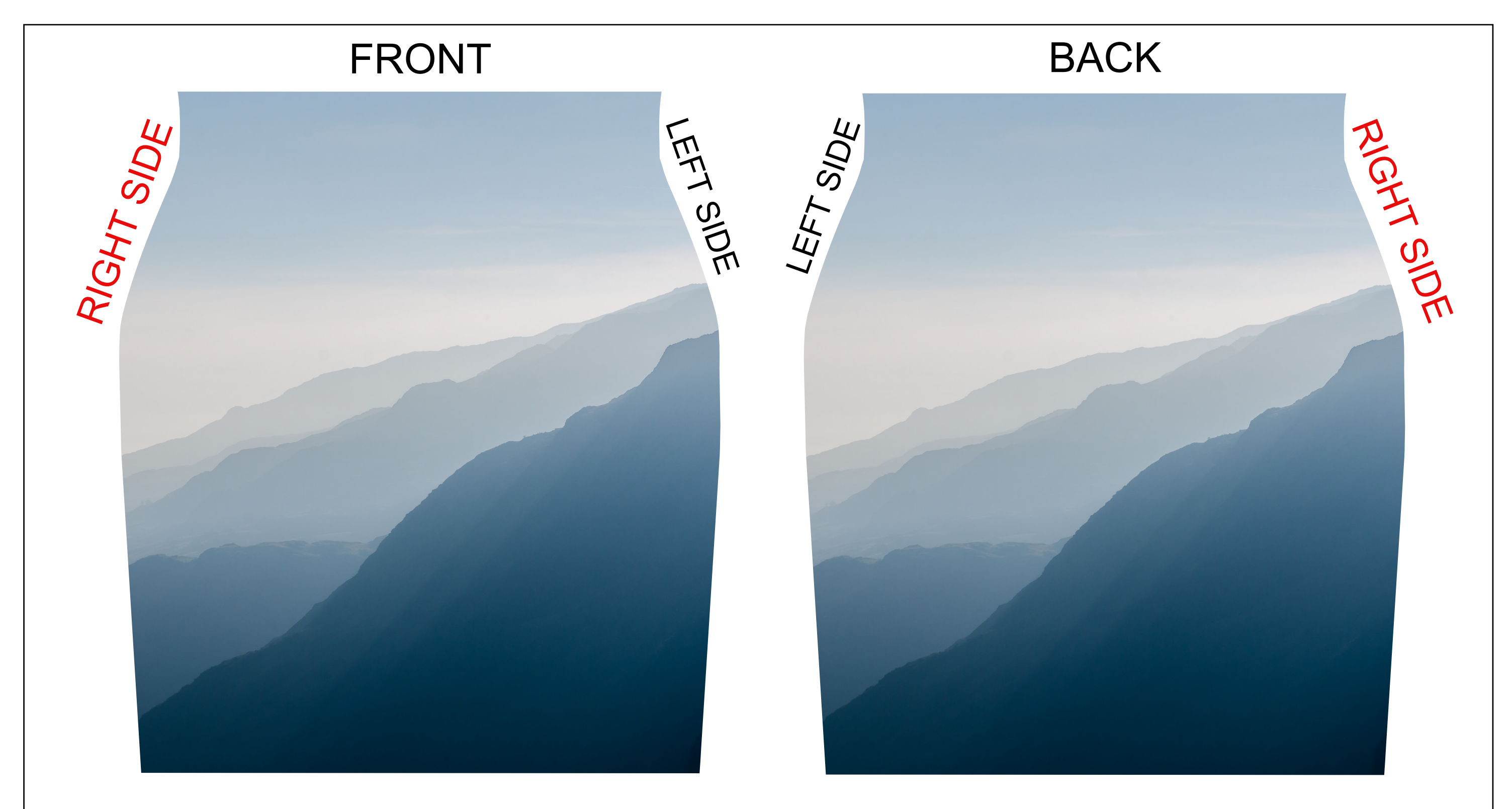
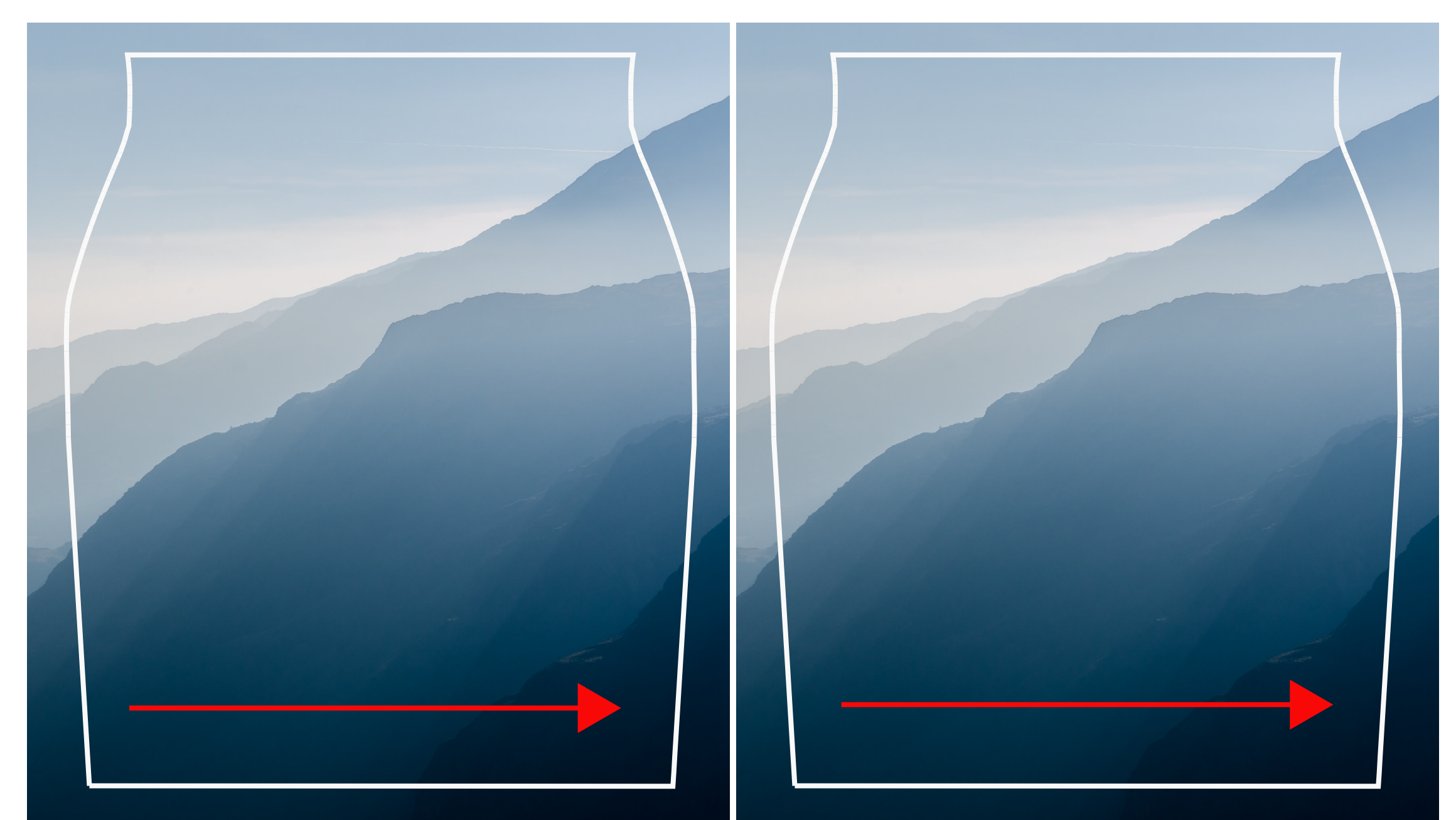

## Custom logo

You need to create a separate print file for your custom pencil skirt logo and submit it along with your pencil skirt print file. The custom logo template is found in the downloadable pencil skirt print file folder.

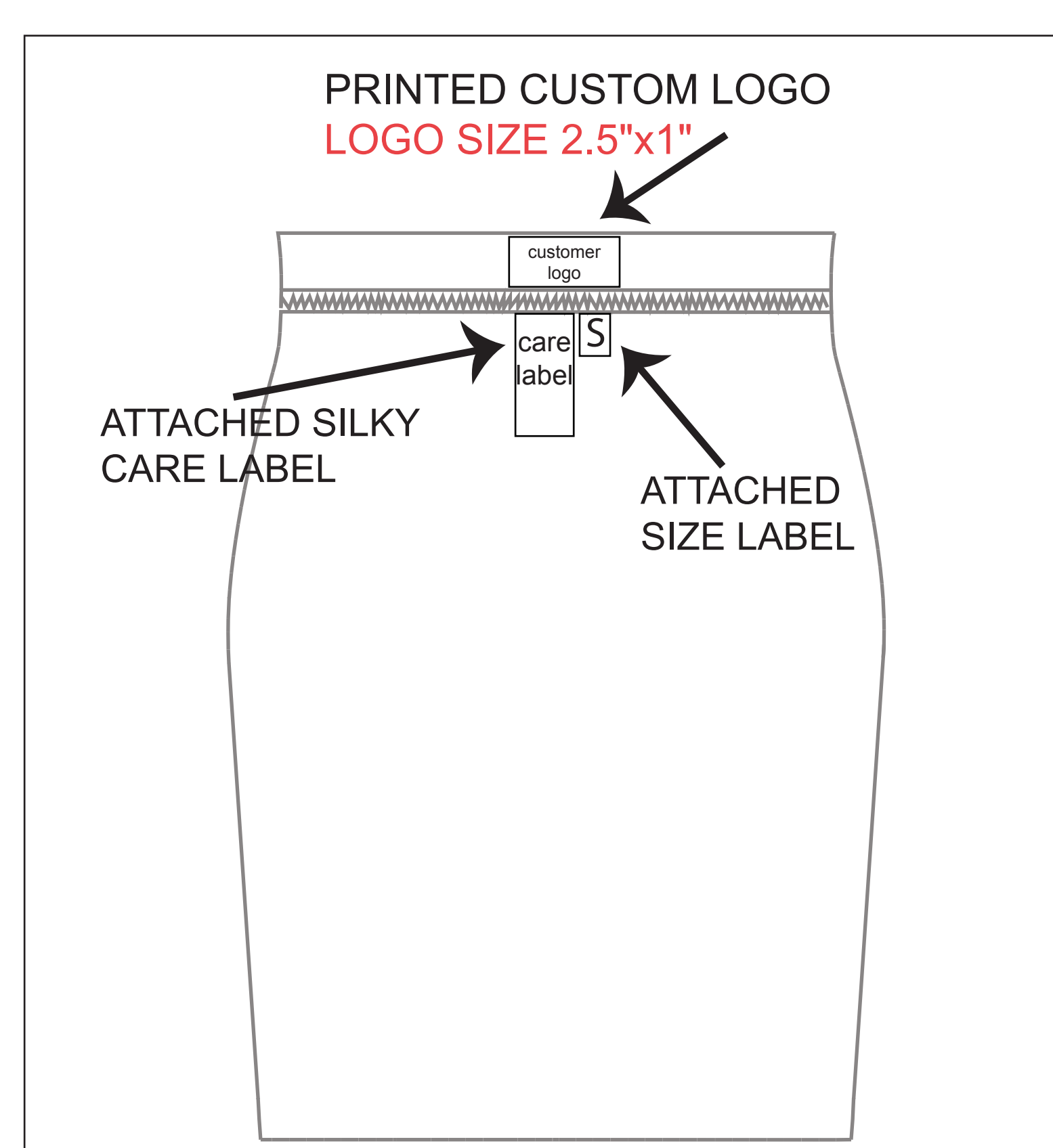

## Instructions on how to prepare a printfile

**Ai**

**Ps**

- 1 CREATE** new document sized to Width: 46.5" x Height: 26.5"
  - Make sure Raster effects are set to **150dpi** or higher
  - Make sure the color space is set to **RGB**

- 1 OPEN** The Printful template or **CREATE** new document

- 2 PLACE** raster graphics or create / copy & paste vector graphics within maximum graphic size area.  
*Pay attention to graphics resolution (see requirements above).*

- 2** Create or copy / paste graphics within maximum graphic size area.  
*Pay attention to graphics resolution.*

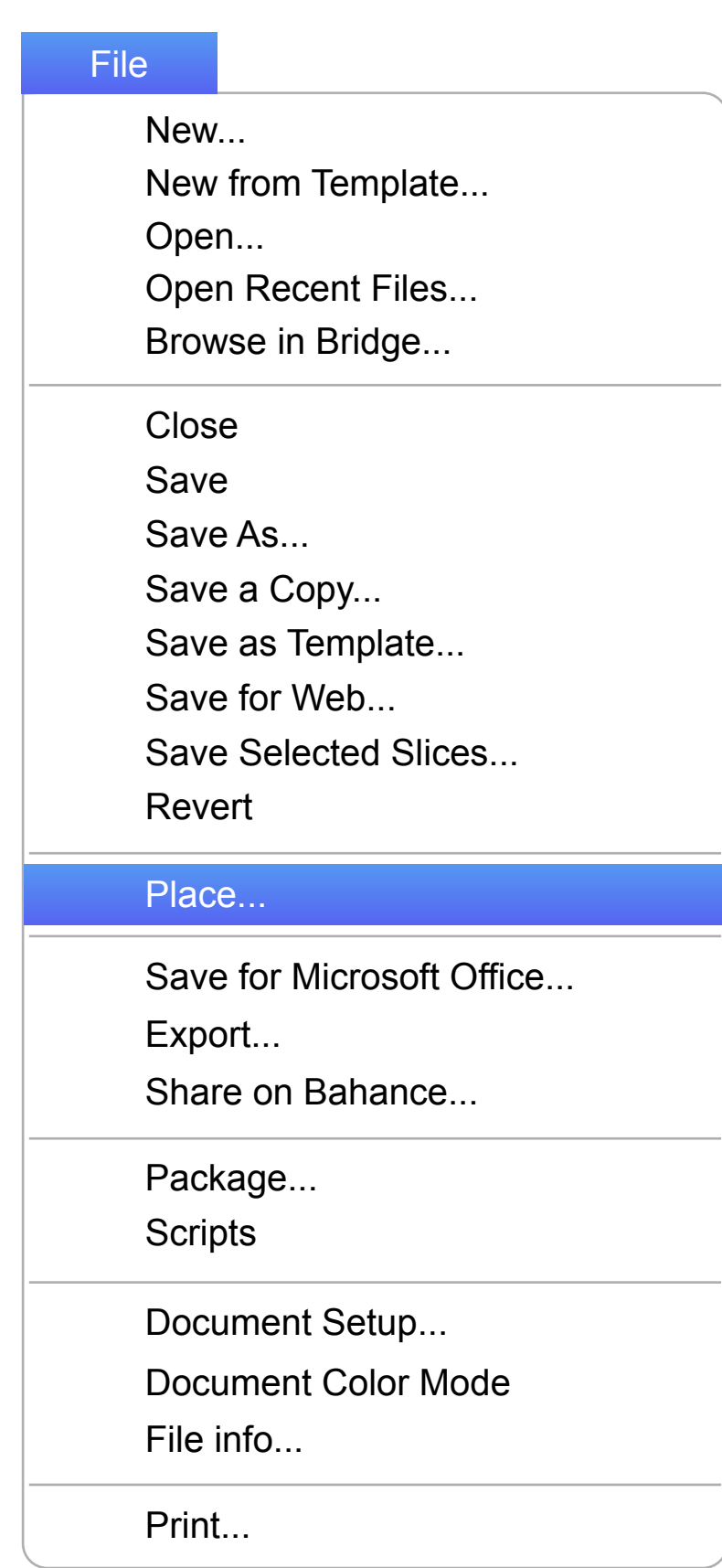

- 3 CONVERT TO SHAPE** all vector fonts  
*Select text layer first*

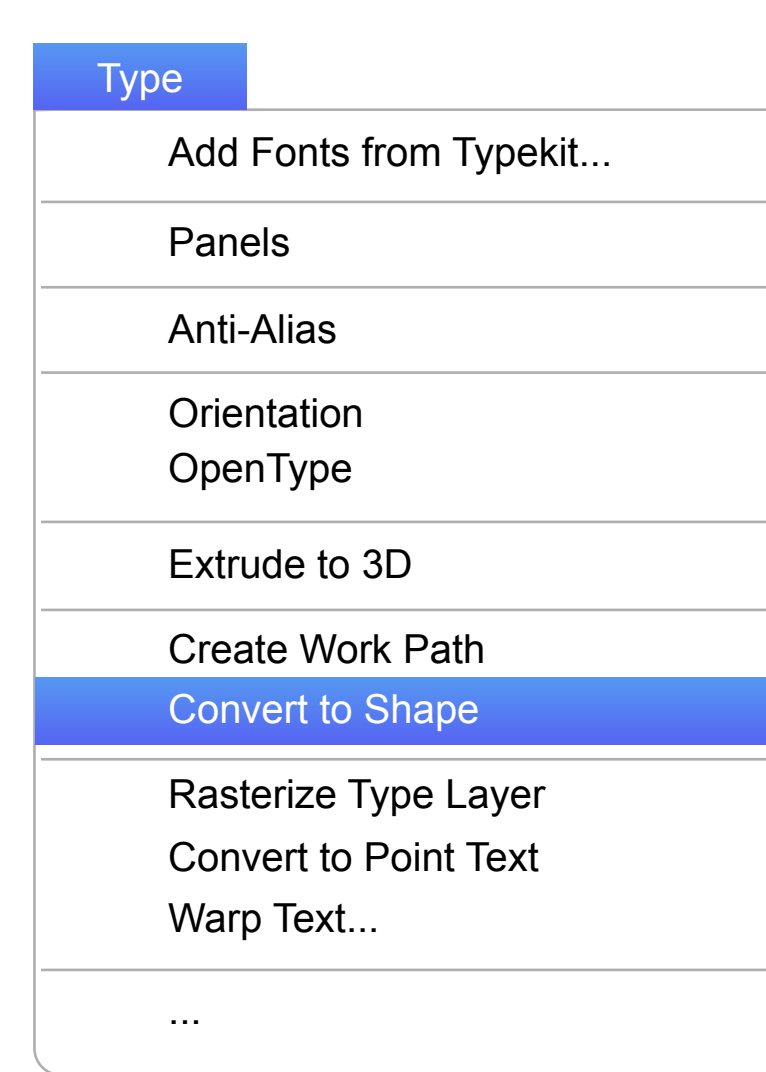

- 3 EMBED** raster graphics

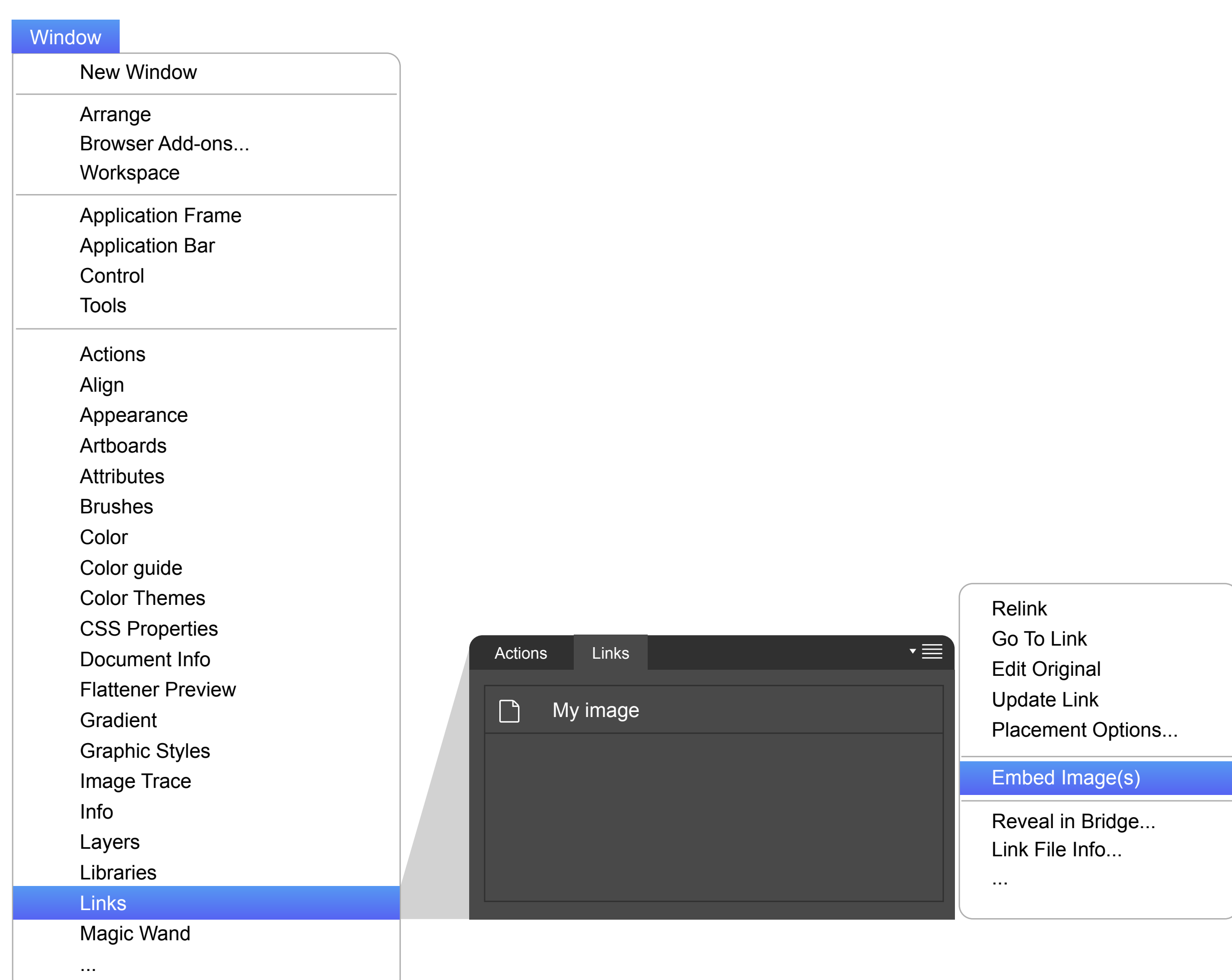

- 4 SAVE**
  1. Turn off the guides by using the eye icon tool
  2. Choose File - Save As and Rename your file
  3. Save as .jpg

- 4 CREATE OUTLINES** of all vector fonts  
*Select text first*

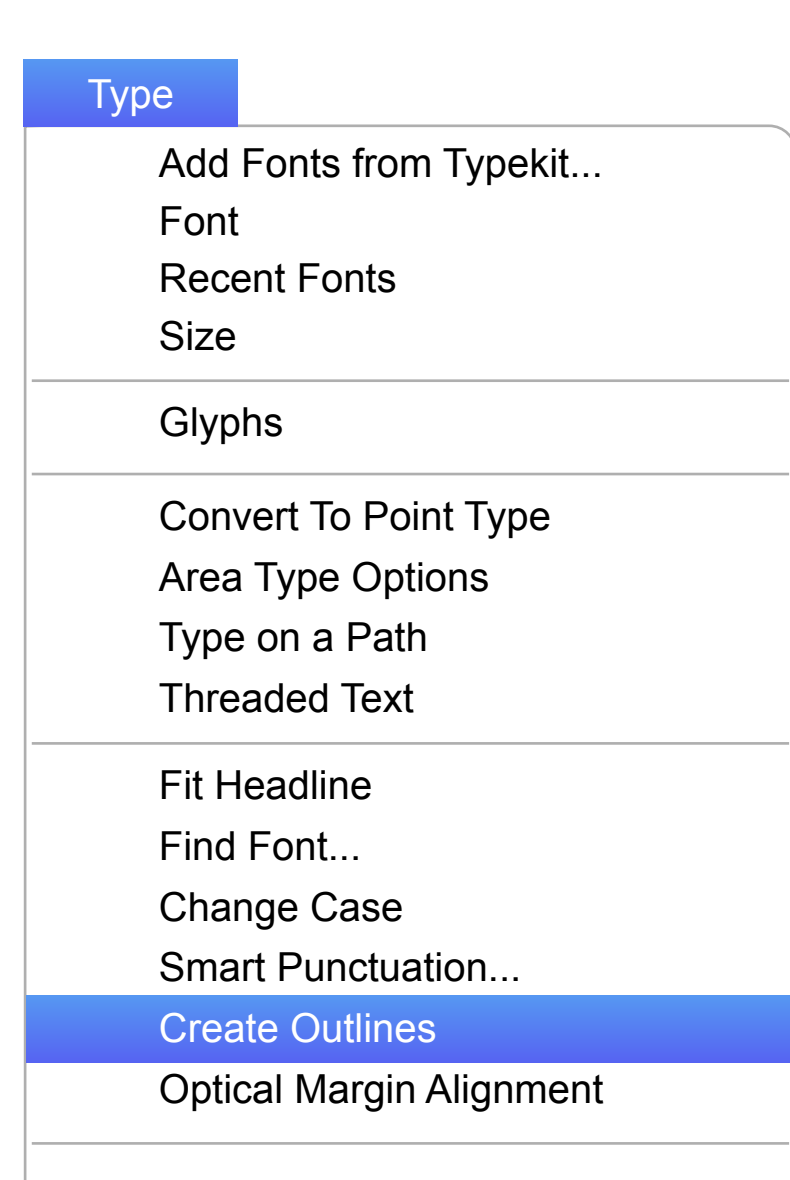

- 5 EXPORT**
  1. Choose "File" - "Export"
  2. Rename your file
  3. Choose either **.png** or **.jpg** as the file format
  4. Click the **"Use Artboards"** checkbox
  5. Click "Export"
  6. Make sure your **resolution is 150dpi** or higher
  7. Make sure the **resolution is set to RGB**
  8. Click **"OK"** to save file